

HGQ 2117 D5
Flat fan nozzle

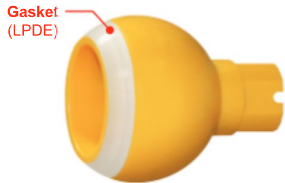

PLASTIC SWIVEL BALL NOZZLES

HGQ and RGN plastic swivel ball nozzles are designed for diversified applications. They allow an easy adjustment of their spray jet direction and offer a quick-fit connection.

- **Nozzle type** Flat fan nozzles (HG)
Hollow cone nozzles (RG)
- **Typical application** Cleaning equipment used in pre-treatment for coating process
- **Material** Body **D5** PP, talcum filled
D6 PP, chemically bonded fiberglass

FLAT FAN NOZZLES

HGQ flat fan nozzles feature a 60° spray angle and their wide range of flow rates makes them the best choice in pre-treatment plants. For an easier identification and use, they are made in different colours depending on the flow rate. The material is top quality PP, chemically bonded fibreglass to offer the best stability at high temperatures and resistance to chemicals.

	Code	Capacity at different pressure values (l/min) (bar)						Color	W g
60°	HGQ 1390 xx	1.70	2.00	2.40	2.90	3.30	Black	16	
	HGQ 1770 xx	3.20	3.80	4.50	5.50	6.40	Purple		
	HGQ 1980 xx	4.00	4.70	5.60	6.90	8.00	Brown		
	HGQ 2117 xx	4.60	5.50	6.50	8.00	9.30	Yellow		
	HGQ 2135 xx	5.50	6.50	7.80	9.50	11.0	Gray		
	HGQ 2155 xx	6.20	7.40	8.80	10.8	12.5	Red		
	HGQ 2195 xx	7.80	9.20	11.0	13.8	15.6	Green		
	HGQ 2230 xx	9.50	11.3	13.5	16.3	19.1	Blue		
	HGQ 2270 xx	10.9	12.8	15.4	18.8	21.7	Sky blue		
	HGQ 2337 xx	13.8	16.4	19.5	24.0	27.7	White		
	HGQ 2410 xx	16.7	19.8	23.6	29.0	33.5	Pink		

Pressure (bar) 0,5 0,7 1,0 1,5 2,0

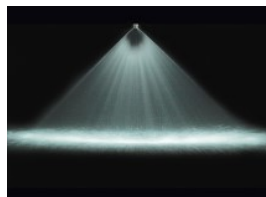
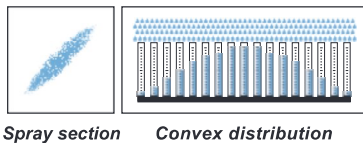
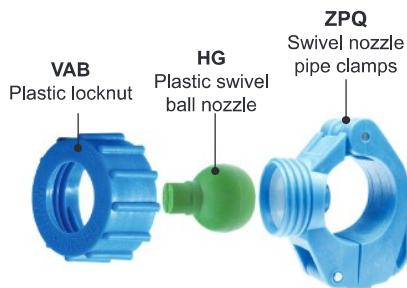

HOLLOW CONE NOZZLES

RGN hollow cone nozzles have a 50° spray angle and offer a wide range of flow rates, all identified by a particular nozzle colour to avoid any possible confusion. The material is top quality PP, chemically bonded fibreglass to offer the best stability at high temperatures and resistance to chemicals. For these features they are widely used in pre-treatment plants.

	Code	Capacity at different pressure values (l/min) (bar)						Color	W g
50°	RGN 2175 xx	7.10	8.50	10.1	12.4	14.3	Red	25	
	RGN 2215 xx	8.80	10.4	12.4	15.2	17.6	Blue		
	RGN 2390 xx	15.9	18.8	22.5	27.6	31.8	Black		

Pressure (bar) 0,5 0,7 1,0 1,5 2,0

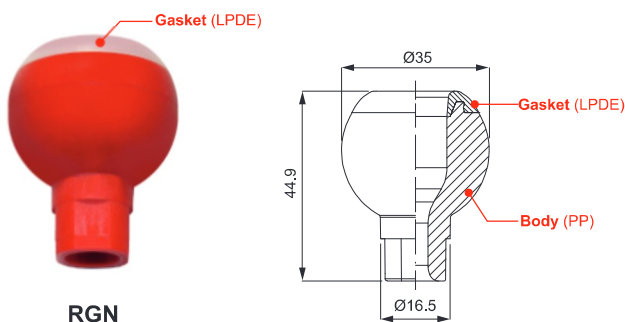

RGN
Hollow cone nozzle

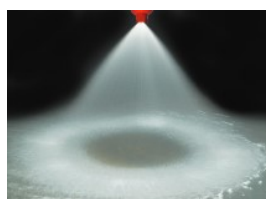
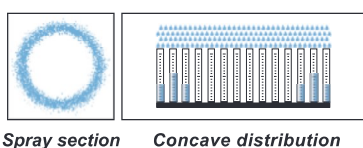

HOW TO MAKE UP THE NOZZLE CODE

EX.: HGQ 1390 D5

- NOZZLE TYPE**
 - HGQ - Flat fan nozzles (60°)
 - RGN - Hollow cone nozzles (50°)
- CAPACITY**
 - D5 - PP, talcum filled
 - D6 - PP, chemically bonded fiberglass
- MATERIAL**